



# ZEPHYRUS<sup>®</sup> GelCube Illuminator

## Instructions for Use

*Ref. No.: Z-DOC-505-B – LED bluewhite  
Z-DOC-505-C – LED CyanW*





## Content

Introduction .....	3
Warnings .....	3
Unpacking.....	3
Product description.....	4
Setup .....	5
Technical specification .....	6
Scanning gel .....	7
Scanning Western blot/colorimetric stained gel .....	8
Browse scanned images/delete scanned images .....	8
Installation of amber filter board.....	9
Menu .....	10
Warranty .....	165



## Introduction

Thank you for purchasing ZEPHYRUS® GelCube LED Imager. This compact instrument is designed to provide high performance in sensitivity for the detection of blue light-excitable fluorescent stained DNA/RNA gels without exposure to dangerous UV light. The white light is suitable for imaging Western blots.

An orange photo filter is included with the system. This filter is designed to absorb (block) blue excitation light from a blue light source, allowing through only the fluorescing sample light for capturing gel images.

## Warnings

Read this manual in its entirety before operating the ZEPHYRUS® GelCube LED Imager and keep the manual for future reference.



**CAUTION:** When using blue light transilluminators: Although blue light does not pose the same hazards as UV light, the emitted blue light is very bright. It is not recommended to look directly at the blue light illumination surface.



**CAUTION:** When working in a laboratory environment, it is always important to properly handle all reagents and chemicals. Use proper and common laboratory safety practices when working with reagents and gels stained with DNA dye. Always wear gloves.

## Unpacking

**NOTE:** Always handle the ZEPHYRUS® GelCube LED Imager and parts with care.

Carefully remove the system and all accessories from the carton and remove any protective pieces. Check for any shipping damage. In the event of shipping damage, a claim must be filed with the carrier. Check the contents of the package to make sure you have received all of the parts ordered:

- Imaging box
- Extending adapter
- Amber photo filter
- Black plastic board
- QIG
- Gel cutting knife
- Gel shovel

- Flash Drive (16G) USB. 3.0



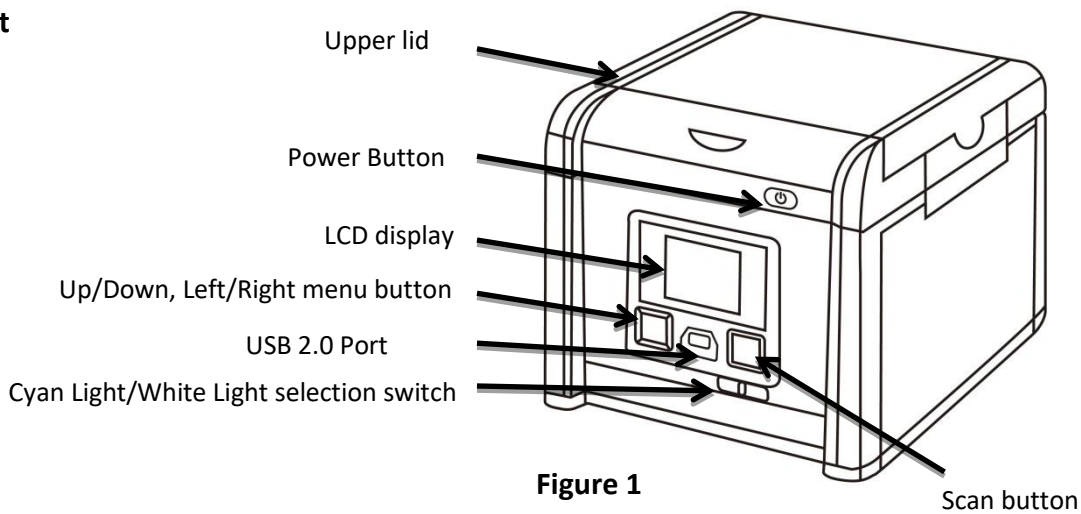
- User's manual

If any parts are damaged or missing, please immediately contact Elisabeth Pharmacon Ltd. at +420 542 213 851 or email [info@elisabeth.cz](mailto:info@elisabeth.cz)

**IMPORTANT: Save the carton and packing materials for storing and transporting ZEPHYRUS® GelCube LED Imager or returning it for any required servicing.**

### Product description

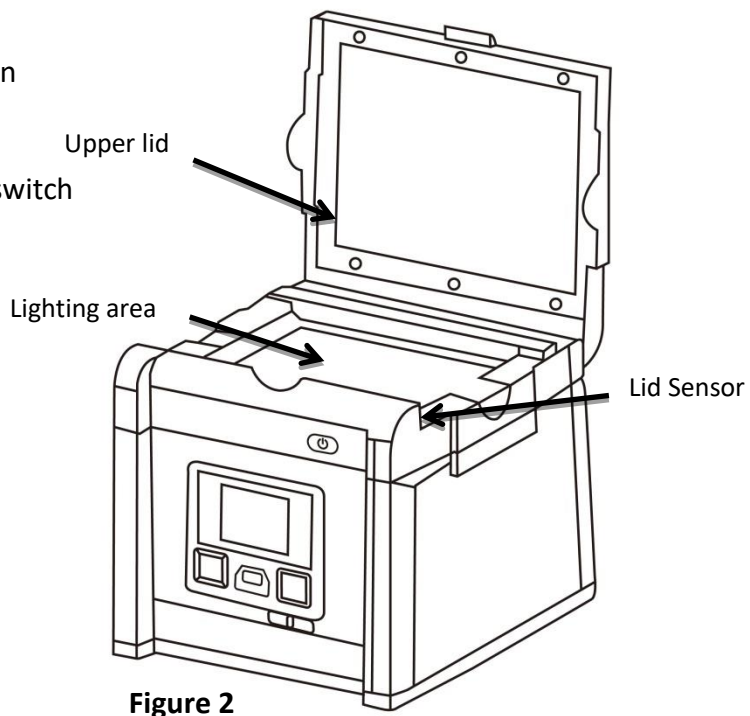
#### Front



### SCANNER COMPONENTS

#### Front (Figure 1):

- Up/Down, Left/Right menu button
- USB 2.0 Port
- Scan button
- Blue Light/White Light selection switch
- Power On/Off Button
- LCD display
- Upper lid



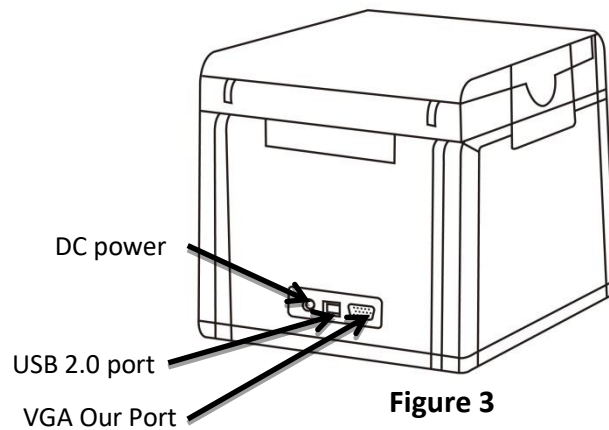


**Inside (Figure 2):**

- Upper lid
- Lighting area
- Lid Sensor

**Back (Figure 3):**

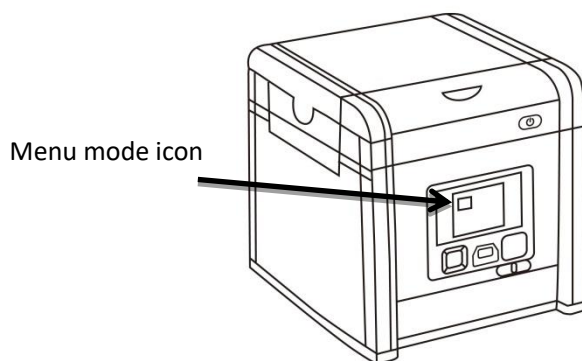
- DC power
- USB 2.0 port
- VGA port



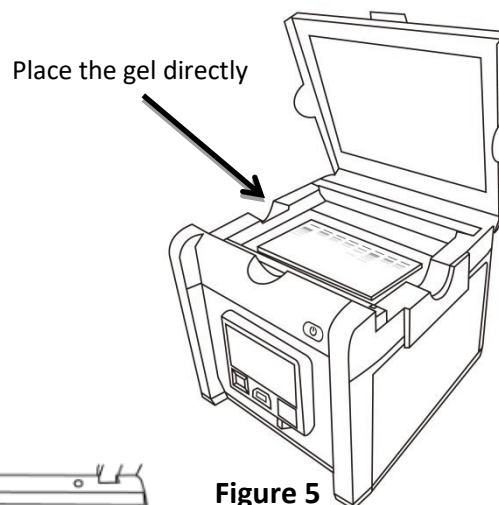
**Figure 3**

**Setup**

1. Remove all tapes used to hold items in place for shipping.
2. Place ZEPHYRUS® GelCube LED Imager on flat surface.
3. Connect power source – connect AC adapter to back of unit then plug into electrical outlet.
4. Push power button.
5. Insert USB flash drive.
6. The Menu Mode icon will be displayed on the top left side of the display (Figure 4).
7. Place gel directly on the surface of the Lighting area (Figure 5).
8. Adjust the image condition and scan.

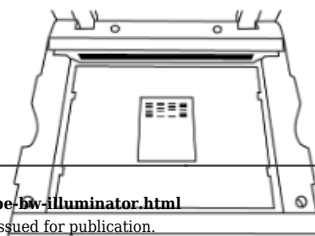


**Figure 4**



**Figure 5**

Place gel to the centre of the





lighting area.

**Figure 6**

### Technical specification

#### Image capturing unit

<b>Sensor</b>	CMOS Sensor
<b>Resolution</b>	9M Pixels
<b>Exposure Time</b>	0.1~2 sec
<b>Image Storage</b>	USB Flash Drive
<b>View Area</b>	16 x 10.5 cm (Fixed Lense)

#### Lens and Filter

<b>Filter Turret</b>	Manual-Driven
<b>Emission filter</b>	Amber filter

#### Lighting

<b>Z-DOC-505-B</b>	blue LED light - bluishwhite
<b>Z-DOC-505-C</b>	cyan LED light - greenwhite
<b>Epi White Light</b>	LED White Light
<b>White Back Light</b>	White Light Panel

#### Interface


<b>Display Panel</b>	Build-in 2.7" Touch TFT LCD
<b>Output</b>	1. USB 2.0 x2 (Thermal printer and USB flash drive ) 2. VGA out ( 800x600, 1024x768)

#### General Info

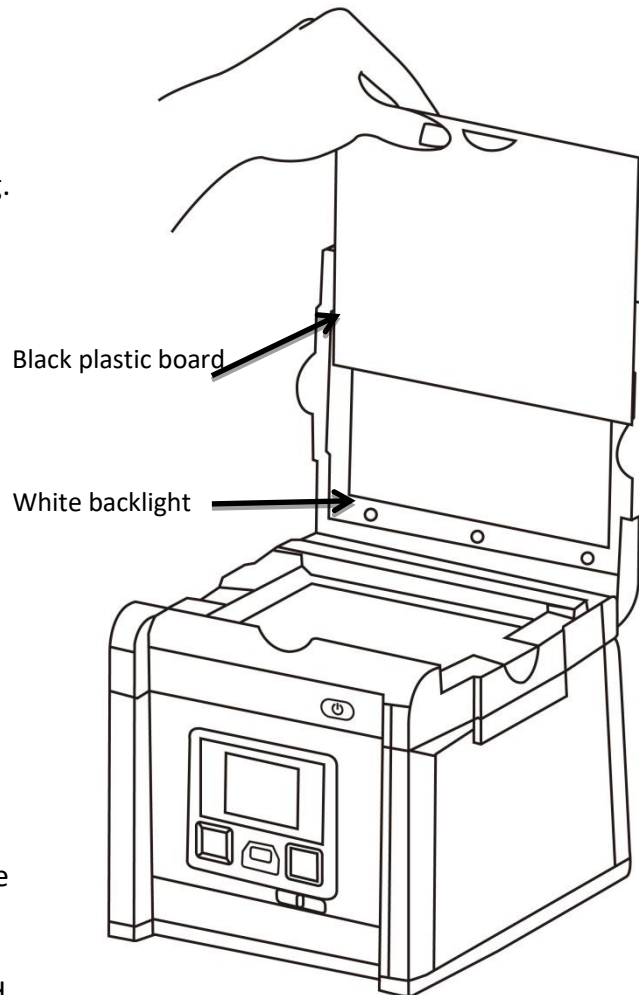
<b>Power</b>	AC Adaptor, 12V/4.6A
<b>Dimensions (WxHxD)</b>	230x230x254mm
<b>Gel Tools</b>	Shovel, Amber View Shield
<b>Weight</b>	3.2 kg
<b>Certification</b>	CE



## Scanning gel

1. Slide the Light Selection Switch on the front side of the scanner to select the white light source for stained gel scanning.
2. In "Scanning Mode" , lift the lid to open the scanner.
3. Slide the black plastic board into the groove of the white backlight to block the white light on the lid\* (**Figure 7**).
4. Place the imaging subject to the center of the lighting area.
5. Close the scanner lid.
6. Slide the Light Selection Switch on the front side of the scanner to choose green light source for scanning stained gel.
7. Set and adjust the desired image quality through the Functional Menu if necessary (Please check "Functional Descriptions" section for the details of all functions).
8. Press SCAN button, green LED will flash and "CAPTURING" will be displayed on the screen. If thermal printer had been connected with ZEPHYRUS® GelCube LED Imager, "Printing Yes/No" will be displayed on the screen. The scanned image will automatically save to USB flash drive.

Scanning of the gel sample is now complete.




**Figure 7**

Slide the black plastic board to avoid the background light for fluorescent stained gel scanning.

(\* It is suggested to slide the black plastic board to block the white backlight on the lid for fluorescent stained gel scanning.)



### Scanning Western blot/colorimetric stained gel




1. Slide the **Light Selection Switch** on the front side of the scanner to select the white light source for stained gel scanning.
2. In **“Scanning Mode”** , lift the lid to open scanner.
3. Make sure there is no black plastic sheet blocked in front of the white back light.
4. Place the imaging subject to the center of the lighting area.
5. Close the scanner lid.
6. Set **“White Epi”** or **“White Back Light”**\* item through Function Menu (Please check **“LED Lighting”** in **“Function Menu Options”** section for turning on **“White Epi”** or **“White Back Light”** options).
7. Adjust the desired image quality through the Functions Menu if necessary (Please check **“Function Menu Options”** section for the details of all functions).
8. Press **SCAN** button, green LED will flash and **“CAPTURING”** will be displayed on the screen (If thermal printer has been connected to the scanner, **“Printing Yes/No”** will be displayed on the screen.).
9. The scanned image will automatically be saved to USB flash drive.

Scanning of the blot is now complete.

\* **“White Back Light”** mode is to scan the gel such as SDS-PAGE stained with coomassie blue and further in a transparent background preservation.

### Browse scanned images/delete scanned images

#### Examine Scanned Images

- a. When  icon displays on top left corner of the screen, press **“OK”** to get into functional options.
- b. When **“Scan Mode”** icon is highlighted , press **“OK”** again to get into **“Play Mode”**.
- c. The **“Play Mode”** icon  will display on top left corner of screen. Then, the captured images can be reviewed one by one by pressing right arrow button.
- d. Press up/down arrow button, the image can be zoomed in/out and be moved upward/downward and leftward/rightward.

#### Delete Scanned Images

- a. When viewing the image that needs to be deleted, press **“OK”** to get into

#### Function Descriptions II.



- c. Press up/down arrow button to choose **“Edit Mode”**. Press right arrow button to select (yes/no) to delete the file.





## Installation of amber filter board

ZEPHYRUS® GelCube LED Imager is equipped with an amber filter board for green light protection and gel cutting purposes. Open the lid and install the filter board so the gel cutting task may be conducted.

1. Open the lid, cyan light will auto turn off
2. Lift the lid to its maximum open angle
3. Position the amber filter board with the hole for hanging on lid in front (**Figure 8**).
4. Place the amber filter board onto the filter board hanging tab so the filter board may hang as shown in (**Figure 9**).
5. When hanging on the lid, make sure the two small pins on the filter board are placed closely against the lid.
6. The installation is completed. One may turn on cyan LEDs by “Scan button” for further gel cutting purpose by using the provided gel cutting knife.

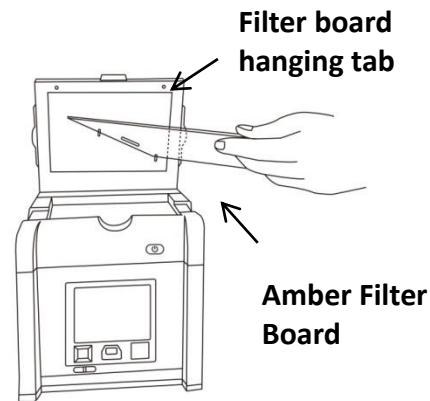


Figure 8

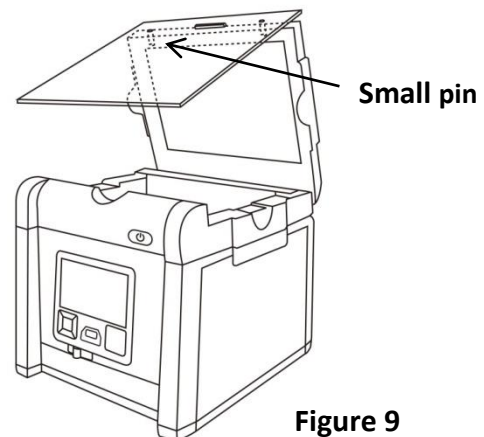


Figure 9

## DISPLAY SCANS ON Monitor or Projector


The display from the scanner can be displayed on a television rather than the built in scanner preview screen using the VGA port.

1. Set the television to VGA mode (see monitor documentation for details).
2. Connect the included VGA cable to the video port on the monitor.
3. Connect the other end of the cable to the VGA port on the back of the scanner.
4. Video output from the scanner can now be seen on the connected monitor including the full menu interface.



## Menu

**Functional Menu:** When image display on screen in yellow border, press “OK” button so the functional icon will show on the left upper corner.

A. Function Descriptions I: 



Scan Mode: The object is able to be scanned in this mode.



Transmitted/Epi image scan, respectively (Note: this mode is available only when white light application is selected.)



Exposure Mode: To adjust the exposure time frame in this mode.

Set Up Mode: To set up the following parameters:

G/W Switch Mode: To scan/display the image in monochrome and normal/invert mode. Default setting: monochrome (black & white)

a. LCD: Dark, Normal, Bright

b. Display: LCD, VGA

c. Video Output: 800x600, 1024x768

d. Save Format: TIF, JPG, BMP, (“JPG” is default setting)

e. Quick View: 1 sec, 2sec, 3 sec, off (“2sec” is default setting)

f. Slide Show Interval: 2 sec, 3sec, 5 sec, 10 sec (“3sec” is default setting)

g. Power Save: 1 min, 3 min, 5 min, 10 min (“1 min” is default setting)

h. Language: english, japanese

i. Date: setup date yyyy/mm/dd

j. Time: setup time hh/mm/ss

k. Reset: Yes, No. (Reset all current settings back to factory default)

l. Reset: Yes, No. (If “YES”, reset all current settings back to factory default)

m. About: Unit Name, S/W version, F/W version, Update, CWD information





Functional Menu:

## B. Function Descriptions II:



Play Mode: To play the captured images. To examine the captured image.



Move/Zoom Mode: Zoom in/out captured images by pressing   buttons. By pressing up/down arrow button and left/right arrow button, the image can be moved upward/downward and leftward/rightward.

Press  to exit the Move/Zoom Mode.



Auto Play Mode: To automatically play the captured images one by one.



Edit Mode: To edit the captured images (such as to rotate or to delete the captured image, etc...)



Preview Mode: To preview the captured images in a multi-image thumbnail panel.




Set Up Mode: Same as the “Set Up Mode” functions in Function Descriptions I.

## C. Function Descriptions I:



### “Scan Mode”




When  icon displays on top left corner of the screen, the object is ready to be scanned.

### “LED Lighting Mode”



a. When in “Scan Mode”, press “OK” to get into functional option list.

b. Press right arrow button to choose “LED Lighting Mode” .



c. Press up or down arrow button to choose light source (Transmitted & Epi<sup>1</sup>).

d. Press “OK” to save the setting.



\*: “LED Lighting Mode” Is only available when switching to white light application.



### “Exposure Mode”

- When  icon displays on top left corner of the screen, press “OK” to get into functional option list.
- Press right arrow button to choose “Exposure Mode” .
- Press up or down arrow button to choose the desired exposure level.
- When the desired exposure level is selected, press “OK” to get back to “Scan mode”.



### “Target Type Mode”

- When  icon displays on top left corner of the screen, press “OK” to get into functional option list.
- Press right arrow button to choose “G/W Switch Mode” .
- Press up or down arrow button to choose to select the desired display mode (G & W; color invert or G & W invert).
- Press “OK” again to return to “Scan Mode”.

\*: The default setting of the scanner is Black & White in normal condition.

<sup>1</sup>: “Color/Color Invert” option only occurs when in white light application.

### “Set Up Mode”

- When  icon displays on top left corner of the screen, press “OK” to get into functional option list.
- Press right arrow button to choose “Set Up Mode” .
- Press down arrow button to get into “Setup Menu” and select the desired setting item.
- Press right arrow button to get into setting mode. Then press up and down arrow button to select the desired setting. Press “OK” to save the setting.
- Press down arrow button to select other setting mode; or press “OK” again to return to “Scan Mode”.





#### Setup Menu and related setting items:




- a. LCD: Dark, Normal, Bright
- b. Display: LCD, VGA
- c. Video Output: 800x600, 1024x768
- d. Filename: Edit scanned file name (6 characters maximum)
- e. Save Format: TIFF, JPG, BMP
- f. Quick View: 1 sec, 2 sec, 3sec, off
- g. Slide Show Interval: 2 sec, 3sec, 5 sec, 10 sec
- h. Power Save: 1 min, 3 min, 5 min, 10 min
- i. Language: english, japanese
- j. Date: yyyy/mm/dd
- k. Time: hh/mm/ss
- l. Reset: Yes, No. (If "YES", reset all current settings back to factory default)
- m. About: Unit Name, S/W version, F/W version, Update, CWD information

#### D. Function Descriptions II:





##### "Play Mode"



- a. When  icon displays on top left corner of the screen, press "OK" to get into functional options.
- b. When "Scan Mode" icon is highlighted , press "OK" again to get into "Play Mode".
- c. The "Play Mode" icon  will display on top left corner of screen. The captured images can then be reviewed one by one by pressing right arrow button.
- d. Press "OK" twice to get back to "Scan Mode" (It will take few seconds to complete the process.)






##### Move/Zoom Mode

- e. Move/Zoom Mode: Zoom in/out captured images by pressing   buttons. By pressing up/down arrow button and left/right arrow button, the image can be moved upward/downward and leftward/rightward.




Press  to exit the Move/Zoom Mode.



### “Auto Play Mode”




- When in “Play Mode” , press “OK” to get into functional option list. 
- Press right arrow button to choose “Auto Play Mode” , then press “OK”.
- The captured image will automatically display on LCD screen one by one.

### “Edit Mode”

- When in “Play Mode” , press “OK” to get into functional option list. 
- Press right arrow button to choose “Edit Mode” .
- Press down arrow button to get into “Edit Menu” (**Rotate/Delete**) and select the desired setting item.
- Press right arrow button to get into setting mode:
 

Rotate: Right 90°	Delete: No
Left 90°	Yes
180°	
Flip horizontally	
Flip vertically	
- Press up and down arrow button to select the desired setting. Press “OK” to save the setting.
- Repeat step e. for “delete mode” setting or press “OK” again to return to “Play Mode”.

### “Preview Mode”

- When in “Play Mode” , press “OK” to get into functional option list. 
- Press right arrow button to choose “Preview Mode” .
- Press down arrow button to get into “Preview Menu” (1 X 1, 2 X 2, 3 X 3) and select the desired setting item.
 

Preview Mode: 1 X 1	Display 1 image at a time
2 X 2	Display 4 images at a time
3 X 3	Display 9 images at a time
- Press “OK” button to save the setting.
- The captured images will display on the screen based on the selected preview format setting.

### “Set Up Mode”

Same as the “Set Up Mode” described in “Function Descriptions I” on page 10.



## Warranty

The ZEPHYRUS<sup>®</sup> GelCube LED Imager is warranted against defects in materials, workmanship and normal use for 1 year. If any defects occur in the instrument or accessories during this warranty period, Elisabeth Pharmacon Ltd. will repair/replace the defective parts/replace the instrument at its discretion without charge. Warranty is excluded in the case of following:

- unauthorized repair
- use of spare parts by anyone other than Elisabeth Pharmacon Ltd.
- used in the manner not described in this manual
- damage caused by accident, neglect, misuse, improper service, natural forces or other causes not arising from defects in original material or workmanship

## Manufacturer:

**ELISABETH PHARMACON Ltd.**

Rokycanova 4437/5, Brno-Židenice 615 00

[info@elisabeth.cz](mailto:info@elisabeth.cz) | [www.elisabeth.cz](http://www.elisabeth.cz) | tel.: +420 542 213 851