



# ZEPHYRUS® Vacuum Pump Manifold System Instructions for Use

*Ref. No.: ZVPMS-300*





## Content

Content.....	2
Warnings .....	3
Important Notice.....	3
Unpacking.....	3
Introduction .....	4
Main Part Diagram .....	6
Installation and operation.....	7
Maintenance .....	12
Troubleshooting.....	13
Ordering information .....	14
Warranty .....	15
Appendix .....	16



## Warnings

Read this manual before operating the **ZEPHYRUS® Vacuum Pump Manifold System** and keep the manual handy for future reference.

## Important Notice

This instrument is designed for laboratory use only. Please read this manual carefully before installing and operating. The instrument shall not be modified in any way. Any modification will void the warranty and may result in potential safety hazard. We are not responsible for any injury or damage caused by any non-intended purposes or modification of the instrument without authorization.

1. Check the voltages specified on the tag plate and ensure it matches the voltage in your location.
2. Install the instrument in a clean, dust free and ventilated area.
3. Never use the instrument with any corrosive, chemical substances or flammable gas.
4. The pump is not designed to start against applied vacuum. To prevent the damage, make sure that the pump inlet is exposed to atmospheric pressure before each start. If necessary, the inlet can be vented out by partially unscrewing the Vacuum Regulator knob on the bottom of filter cartridge.
5. The pump has a thermal protection feature that automatically shuts-off the pump when it becomes overheated.
6. The temperature of the surface of pump is very high after use or during work, please do not touch it to avoid burns.
7. Do not use any lubricants, which may damage the pump.
8. Please discard packing material according to local related regulations.
9. Operating condition of vacuum pump
  - (a) Ambient temperature: 5~ 40 °C
  - (b) Relative humidity: 80% RH Max.
  - (c) Power supply: 100~120V, 50/60Hz or 200~240V, 50/60Hz
  - (d) Altitude: up to 2000 m
  - (e) Pollution degree: II
  - (f) IP30
  - (g) Overvoltage category: II
  - (h) Indoor use

## Unpacking

Always handle the **ZEPHYRUS® Vacuum Pump Manifold System** and parts with care.

Check carefully for any shipping damage. In the event of shipping damage, your claim must be filed with the carrier. Carefully remove the system and all accessories from the carton and remove any protective pieces. Check the contents of the package to make sure you have received all parts you have ordered.



## Introduction

The **ZEPHYRUS® Vacuum Manifold UNI**, is universal vacuum manifold, that was primarily designed for rapid extraction of DNA/RNA using the 96-well extraction plate format, however you can also extract NA from up to 24 mini spin columns, 8 midi or maxi columns at the same time using the Adaptor Board.

The **ZEPHYRUS® Vacuum Pump Manifold System**, is offered as a set consisting of a **ZEPHYRUS® Vacuum Manifold UNI** and a **ZEPHYRUS® Vacuum Pump**. This system employs the vacuum created by pump instead of time-consuming centrifugation step that pulls samples through a membrane. Using 96-well plate format saves your time but also simplifies the entire process and eliminates repetitive steps, such as dispensing solution, running and stopping centrifugation.

**Hint:** *“This pump/manifold system is very compact, there is no requirement for additional clean room space to work with extractions, the system easily fits to your existing laminar flow box and unlike many automatic systems, it takes minimum of your bench space.”*

The **ZEPHYRUS® Vacuum Pump Manifold System** can be used with both with 96-well extraction plate but also with spin columns by inserting columns to Luer connectors on Adapter Board. It is suitable for those laboratories that require saving time while working with large sample volumes.

### ● Applications

Plasmid DNA, single-stranded phage DNA, RNA, genomic DNA, viral nucleic acids, DNA cleanup from PCR and other enzymatic reactions.

**Hint:** *“This pump/manifold is compatible with **EliGene® Extraction Kits** for Manual DNA or RNA isolation and easily achieves extraction speeds of automatic systems.”*



## Main Part Diagram

### Zephyrus Vacuum Pump Manifold System (ZVPMS-300)



Model	Standard Package Includes:	
Zephyrus Vacuum Pump Manifold System	Zephyrus Vacuum Pump - Oil Free Vacuum Pump (ZVP-300)	x 1
	Zephyrus Vacuum Manifold UNI - plate Vacuum Manifold (ZVM-300)	x 1
	Spin Column Adaptor Board	x 1
	Spacer Bock A (for Deep Well Collection Plate h=40mm)	x 1
	Luer Connector (25/pk)	x 1
	Luer Stopper (25/pk)	x 1
	Waste Tray	x 1
	Allen Wrench	x 1
	Sealing Kit (O-ring x 1, Gasket x 1)	x 1
	Silicone Tube	x 1
	Instruction Manual	x 1



### Description of Zephyrus Vacuum Pump Manifold System (ZVPMS-300)



Position	Designation	Position	Designation
1	Power Switch	4	Vacuum Regulator, bleeder
2	Muffler	5	Vent
3	Air Inlet	6	Vacuum Connector

### Description of Zephyrus Vacuum Manifold UNI (ZVM-300)



Position	Designation	Position	Designation
1	Lower Chamber	5	Vacuum Vent Switch
2	Upper Chamber	6	Vent
3	Gasket	7	Vacuum Connector
4	Top Ring		



## Installation and Operation

### A. Zephyrus Vacuum Manifold UNI Installation

1. Ensure that the surface of gasket and O-ring are free from dirt or debris. Dirty gasket and O-ring would lead to insufficient hermetic seal.
2. Put a Waste tray inside of Lower Chamber; assemble the manifold by placing the Upper Chamber on the top of it.
3. Put 96-well filter plate or Spin Column Adaptor Board firmly on the gasket of Upper Chamber according to the type of extraction kit.



96-well Extraction Plate



Mini Spin Column x 24



Maxi Spin Column x 8

**Hint:** “When using the Waste Tray inside of the manifold to collect the flow-through buffers, the Waste Tray and the interior parts of Upper and Lower manifold Chambers have to be washed and cleaned thoroughly after each set of extractions to prevent sample contamination.”

### B. Zephyrus Vacuum Pump Manifold System

1. Install the ZEPHYRUS® Vacuum Manifold UNI according to Installation A. 1~3.
2. Turn on the pump and make a test run, block the inlet of the pump and regulate to the desired vacuum level by adjusting Vacuum Regulator on the bottom of Filter Cartridge (4) then turn the pump off. With most filter plates you can leave the Vacuum Regulator fully open (maximum level).
3. Connect the Silicone Tube to a Vacuum Connector of installed ZEPHYRUS® Vacuum Manifold UNI and inlet of ZEPHYRUS® Vacuum Pump as shown in previous diagram.

**Hint:** „Setting the appropriate vacuum degree is a key point to achieve efficient extraction. We suggest setting the vacuum at maximum level according to extraction protocol before starting the extraction.”





### C. Zephyrus Vacuum Manifold UNI Installation

- Before starting, please make sure the system is installed according to instructions mentioned above in point A. and B.
- When using the extraction or purification kits from other producers, please follow the “vacuum protocol” in the relevant kit instruction for use manual.
- ZEPHYRUS<sup>®</sup> Vacuum Manifold UNI can be also connected to a local stationary vacuum source with optional vacuum regulator to adjust the vacuum degree.
- Please rinse and clean the entire ZEPHYRUS<sup>®</sup> Vacuum Manifold UNI instrument according to the Maintenance instructions after every use to prevent the contamination of your lab.

**Hint:** “To utilize your laboratory plastic waste effectively, you can use the upper or lower part of “used pipette tip boxes” as a waste tray before their ecological disposal.”

#### 1. Using the 96-well Filter Plates for extraction

1. Place one unused 96-well filter plate firmly on the gasket of Upper Chamber.
2. Make sure that the vacuum is switched OFF on the vacuum pump. Also keep the Vent lever on Manifold in shut off position
3. Load your samples in lysis buffer on the 96-well filter plate using multichannel pipette.

**Hint:** “To utilize your 96-well filter plate effectively (when having few samples), you can seal off the unused part of the plate with sticky seal foil (e.g.  $\alpha$ Plastic PCR 96 Well-Plates Adhesive Membrane, AP96MEM-100). The unused part of filter plate is good for 1 month from the first use when stored at 5C.”

4. Turn the pump ON to apply the vacuum, press firmly on all corners of filter plate with both hands to get the proper vacuum seal. To improve hermetic seal you can slightly apply non degradable silicone paste (e.g. Lukosan M 14) on the rubber gasket. You will hear the pump humming when proper seal is accomplished.





5. Wait till the entire volume passes through the plate and is collected in Waste Tray. ***This may take several minutes*** as filter plates are designed to bind nucleic acids most efficiently when lysate passes through the membrane at slower rate. You may also see a slight indentation of filter plate when vacuum seal is achieved.

6. When all liquid passes through, turn the pump OFF. Slowly and carefully open the Vent on the manifold to release the residual vacuum to prevent cross-contamination.

***Hint:*** “Do not release the manifold vacuum pressure by lifting up the corner of 96-well extraction plate. This will result in deformation of the manifold gasket and will affect the hermetic seal for future extractions.”

7. Load the wash buffer on 96-well extraction plate using multichannel pipette.

8. Turn the pump ON to apply the vacuum, press firmly on all corners of filter plate with both hands to get the proper vacuum seal.

9. Wait till the entire volume passes through the plate and is collected in Waste Tray. ***This may take several minutes.*** You may also see a slight indentation of filter plate when vacuum seal is achieved.

10. Repeat the wash steps according to recommendations of kit producers.

11. When finished, turn the pump OFF. Slowly and carefully open the Vent on the manifold to release the residual vacuum to prevent cross-contamination.

12. Before the elution step remove the 96-well extraction plate and set aside. Disassemble the manifold and remove the Waste Tray from inside of the manifold (*or throw away the pipette lid with collected flow through as recommended in Hint section*).

13. Place the Acrylic spacer block or Adaptor Board on the bottom of the manifold. With the block or board sitting on the on the bottom, place one 96 Deep Well Collection Plate to collect the eluate (*follow recommendations of kit producers*).

14. Assemble the manifold by placing the Upper Chamber on the top of Lower Chamber with 96 Deep Well Collection Plate inside of manifold.

15. Put back the 96-well extraction plate firmly on the gasket of Upper Chamber so the protruding column tips sit few millimeters above the 96 Deep Well Collection Plate.

16. Apply the Elution buffer and elute your samples into the 96 Deep Well Collection Plate. Use your samples in succeeding PCR analysis OR perform the elution step with centrifugation to ensure maximal recovery (*follow recommendations of kit producers*).



**Hint:** “You may also remove residual droplets on the bottom of extraction plate by tapping the top of 96-well extraction plate before releasing the vacuum by Vent.”

17. When finished, turn the pump OFF. Slowly and carefully open the Vent on the manifold to release the residual vacuum to prevent cross-contamination.

## II. Using the Spin Columns

1. Put spin column Adaptor Board firmly on the gasket of Upper Chamber.
2. Replace the number of Luer Stoppers with Luer Connectors on Adapter Board according to desired number of used spin columns.

**Hint:** “To ensure the proper vacuum level keep the Luer Stoppers in place on Adaptor Board when working with fewer spin columns.”

3. Insert spin column tip firmly into rubber Luer Connector. Using the same type of columns will prevent different flow through rate.
4. When using **mini spin columns** you may use **disposable Luer Connector Adaptor (ZVM-300 – 16)** to assure a better fit of mini spin column to rubber Luer Connector (clear Combifix Adapter #4090306 from B Braun can be also used).
5. Make sure that the vacuum is switched OFF on the vacuum pump.
6. Load your samples in lysis buffer onto the columns; turn the pump ON to apply the vacuum, press slightly on the edges of Adaptor Board to engage the proper vacuum seal. Wait till the entire volume passes through the plate and is collected in Waste Tray.
4. When finished, turn the pump OFF. Slowly and carefully open the Vent on the manifold to release the residual vacuum to prevent cross-contamination.

**Hint:** “Do not release the manifold vacuum pressure by lifting up the corner of the Adaptor Board. This will result in deformation of the manifold gasket and will affect the hermetic seal in future extractions.”

7. Load the wash buffer onto the columns; turn the pump ON to apply the vacuum, press slightly on the edges of Adaptor Board to engage the proper vacuum seal. Wait till the entire volume passes through the plate and is collected in Waste Tray.
8. Repeat the wash steps according to recommendations of kit producers.



9. When finished, turn the pump OFF. Slowly and carefully open the Vent on the manifold to release the residual vacuum to prevent cross-contamination.
10. Set the Adaptor Board aside and disassemble the manifold, remove the Waste Tray from inside of the manifold (or throw away the pipette lid with collected flow through as recommended in Hint section).
11. Before proceeding further to elution step, remove all columns from Adaptor Board and **proceed with centrifugation** on your laboratory centrifuge. To ensure maximal recovery of nucleic acids follow recommendations of kit producers.
12. Apply the Elution buffer and elute your samples into collection tubes. Use your samples in succeeding PCR analysis or other downstream applications.

How to use :

### Zephyrus Vacuum Pump Manifold System

### Zephyrus Vacuum Manifold UNI



1



Put the upper chamber on the top of lower chamber with waste tray in it.

2



Connect the manifold and vacuum pump together with silicone tube.  
 • Adjust the vacuum with pump regulator before operation.

3

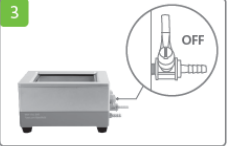

Make sure the vent is **closed** and choose spin columns or 96-well plate for extraction.

➡ Spin columns

➡ 96-well plate

4-1a



Place the column adaptor board on the gasket of upper chamber.

4-1b

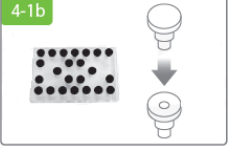

Replace the Luer stoppers with Luer connectors which the number is same as spin columns.

4-1c



Insert the spin columns firmly to Luer connectors and load the samples.

4-2a



Place the 96-well plate on the gasket of upper chamber.

4-2b



Load the samples and ready for extraction.  
 • Every well should be filled to make sure no air leakage.

5



Turn on the vacuum pump, press lightly on column adaptor board or 96-well plate to seal the top ring and start extraction.

6

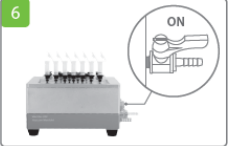

Turn off the vacuum pump after extraction and **open** the vent to release the vacuum.

7



Remove column adaptor board or 96-well plate.

8



Discard the waste and clean manifold with paper towels.

Created by: VIJU  
 Source: <https://www.elisabeth.cz/produkt-zephyrus-vacuum-pump-manifold-system-cz.html>  
 This file is owned by ELISABETH PHARMACON, spol. s r. o., It is issued for publication.  
 Downloaded: 03.07.2024 06:54 online user

11

Instruction for use ZEPHYRUS® Vacuum Pump Manifold System

Version: 200820-04  
 Page 11 of 16



## Maintenance

1. Please clean the ZEPHYRUS® Vacuum Manifold UNI with water and either air dry or wipe with paper towels after every use. Do not use any harsh chemicals including solvent, bleach, or abrasives.
2. In case you need to remove contaminating nucleic acids we are recommending to use the **EliGene® Lab Cleaner B** which is a granular agent with maximum efficiency for degrading nucleic acids (DNA, RNA) and DNase / RNase. The prepared solution can be used for cleaning plastic surfaces of instruments, Plexiglas, table tops, glass surfaces, pipettes (the solution does not damage plastics).
3. ZEPHYRUS® Vacuum Manifold UNI instrument is autoclavable including silicone tube and all accessories, please clean them thoroughly and autoclave (121°C, 1 bar, 20 min) if needed.
4. The Vacuum Pump is not autoclavable!!! Please clean the surface with pure water, 75% ethanol or Isopropanol (IPA).
5. After finishing the experiment, please keep pumping the air for at least 2 minutes to withdraw the residual steam that may be trapped inside of Vacuum Pump ducts.
6. When the gasket, O-ring are worn off or damaged, please replace them immediately. Do not apply rubber degradable oil or grease to the gaskets or other parts of the ZEPHYRUS® Vacuum Manifold UNI!!!

## Replacement of O-ring and Gasket

- When O-ring and gasket are worn, the proper vacuum level cannot be achieved. Please replace them with new replacement set that is supplied free with this system.
- Both O-ring and gasket should be replaced at the same time.

### O-ring

1. Remove existing O-ring from the bottom of the Upper Chamber.
2. Ensure the new O-ring is free from dirt, debris, and particulate matter.
3. Replace with new O-ring.



## Gasket

1. Remove the 12 screws located on the bottom of Upper Chamber using supplied Allen wrench.
2. Separate the top ring, remove the old gasket, and clean thoroughly the top ring groove.
3. Put the new gasket into the groove and put the top ring back. Please ensure that the bottom of the top ring groove is aligned with cover gasket.
4. Put back the 12 screws and tighten them at corners slightly and lock other screws back. Do not lock too tight too strong otherwise distorted top ring may cause a poor vacuum.

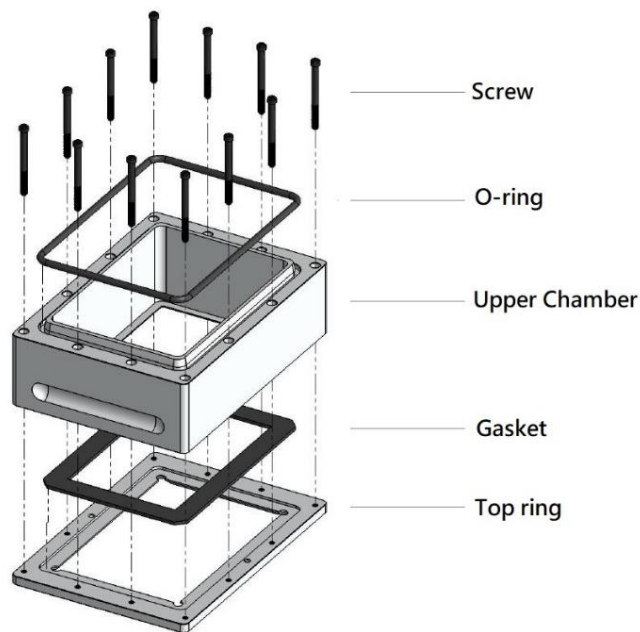

## Troubleshooting

Problem	Reason and Solution
Pump fails to start	<ul style="list-style-type: none"> <li>• Wrong power supply → Reconnect to specified power.</li> <li>• Vacuum exists → Release vacuum and restart pump.</li> <li>• Switch is broken → Contact distributor for assistance.</li> </ul>
Poor vacuum	<ul style="list-style-type: none"> <li>• Improper vacuum setting → Reset vacuum by regulator.</li> <li>• Clogged muffler → Clean or replace a new muffler.</li> <li>• Unused Luer connectors → Replace with Luer stoppers.</li> <li>• Opened vent valve → Close the vent valve.</li> <li>• Cracked plates or adaptor board → change for a new one.</li> <li>• Loose stoppers → Re-plug the connectors and stoppers.</li> <li>• Dirty or damage O-ring and gasket → Clean or replace it.</li> </ul>



## Ordering information

ZVPMS-300	ZEPHYRUS® Vacuum Pump Manifold System
ZVP-300	ZEPHYRUS® Vacuum Pump
ZVM-300	ZEPHYRUS® Vacuum Manifold UNI
ZVM-300 – 1	Spin Column Adaptor Board (24 hole)
ZVM-300 – 2	Spin Column Adapter Board - Acrylic (24 holes)
ZVM-300 – 3	Luer Connector (25/pk)
ZVM-300 – 4	Luer Stopper (25/pk)
ZVM-300 – 5	Silicone Tube, O 6 x 12 mm, 30 cm
ZVM-300 – 6	Silicone Tube, O 6 x 12 mm, 100 cm
ZVM-300 – 7	Waste Tray
ZVM-300 – 8	Sealing kit (includes O-ring, gasket )
ZVM-300 – 9	Allen wrench
ZVM-300 – 10	Vacuum regulator
ZVM-300 – 11	1200 ml PES Vacuum Bottle
ZVM-300 – 12	Muffler for Zephyrus Vacuum Pump ZVP-300
ZVM-300 – 13	96 Deep Well Collection Plate; 2,2 ml; h44 mm
ZVM-300 – 14	96 Deep Well Collection Plate; 2,2 ml; h41 mm
ZVM-300 – 15	96 Well Collection Plate; 1,2 ml; h24mm
ZVM-300 – 16	Luer Connector Adaptor Disposable (100/pk)
ZVM-300 – 17	Spacer Block A (for deep well collection plate; h = 40 mm)







## Warranty

The ZEPHYRUS® Vacuum Pump Manifold System is warranted against defects in materials, workmanship, and normal use for 1 year. If any defects occur in the instrument or accessories during this warranty period, Elisabeth Pharmacon Ltd. will repair/replace the defective parts/replace the instrument at its discretion without charge. Warranty is excluded in the case of following:

- unauthorized repair
- use of spare parts by anyone other than Elisabeth Pharmacon Ltd.
- used in the manner not described in this manual
- damage caused by accident, neglect, misuse, improper service, natural forces, or other causes not arising from defects in original material or workmanship

	<h3><u>Warranty Certificate</u></h3>										
<p>We guarantee the perfect functioning of this instrument against defects in material, design and workmanship, when use under appropriate conditions and in accordance with the instruction manual for a period of <b>ONE YEAR</b> from the date of initial shipment. This warranty covers all parts and components of the instrument except those normally requiring frequent replacement, such as tubing, gasket, rings, etc. We will not be liable for any personal injury, bodily injury, misuse, improper maintenance, negligence or accident.</p>											
<table border="1" style="width: 100%; border-collapse: collapse;"> <tr> <td style="width: 50%; padding: 2px;">Cat. No :</td> <td style="width: 50%; padding: 2px;">Model :</td> </tr> <tr> <td colspan="2" style="padding: 2px;">Serial No :</td> </tr> <tr> <td style="padding: 2px;">Purchase Date :     /   /</td> <td style="padding: 2px;">Name :</td> </tr> <tr> <td style="padding: 2px;">E-mail :</td> <td style="padding: 2px;">Telephone :</td> </tr> <tr> <td colspan="2" style="padding: 2px;">Address :</td> </tr> </table>	Cat. No :	Model :	Serial No :		Purchase Date :     /   /	Name :	E-mail :	Telephone :	Address :		<div style="border: 1px solid black; border-radius: 15px; height: 150px; width: 100%;"></div> <p style="text-align: center; margin-top: 5px;">Distributor</p>
Cat. No :	Model :										
Serial No :											
Purchase Date :     /   /	Name :										
E-mail :	Telephone :										
Address :											
<p><b>ELISABETH PHARMACON Ltd.</b>        Rokycanova 4437/5, Brno-Židenice 615 00  <a href="mailto:info@elisabeth.cz">info@elisabeth.cz</a>   <a href="http://www.elisabeth.cz">www.elisabeth.cz</a>   tel.: +420 542 213 851</p>											













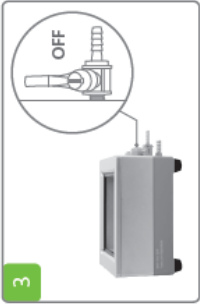

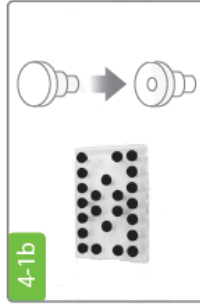
## Appendix

# How to use : Zephyrus Vacuum Pump Manifold System Zephyrus Vacuum Manifold UNI

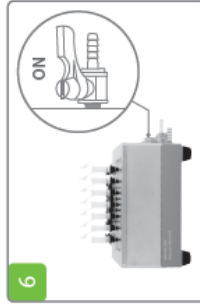
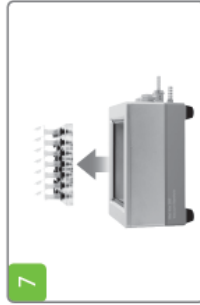

<p><b>1</b></p> 	<p>Put the upper chamber on the top of lower chamber with waste tray in it.</p>	<p><b>2</b></p> 	<p>Connect the manifold and vacuum pump together with silicone tube. - Adjust the vacuum with pump regulator before operation.</p>	<p><b>3</b></p> 	<p>Make sure the vent is <b>closed</b> and choose spin columns or 96-well plate for extraction.</p>	<p><b>Spin columns</b></p> <p><b>4-1a</b></p> 	<p>Place the column adaptor board on the gasket of upper chamber.</p>	<p><b>4-1b</b></p> 	<p>Replace the Luer stoppers with Luer connectors which the number is same as spin columns.</p>	<p><b>4-1c</b></p> 	<p>Insert the spin columns firmly to Luer connectors and load the samples.</p>	<p><b>96-well plate</b></p> <p><b>4-2a</b></p> 	<p>Place the 96-well plate on the gasket of upper chamber.</p>	<p><b>4-2b</b></p> 	<p>Load the samples and ready for extraction. - Every well should be filled to make sure no air leakage.</p>	<p><b>5</b></p> 	<p>Turn on the vacuum pump, press lightly on column adaptor board or 96-well plate to seal the top ring and start extraction.</p>	<p><b>6</b></p> 	<p>Turn off the vacuum pump after extraction and open the vent to release the vacuum.</p>	<p><b>7</b></p> 	<p>Remove column adaptor board or 96-well plate.</p>	<p><b>8</b></p> 	<p>Discard the waste and clean manifold with paper towels.</p>
---	---	---	--	---	---	---	---	--	---	--	--	---	--	--	--	---	---	---	---	---	--	--	--