

Bead Ruptor™ Cryo Cooling Unit

User Manual

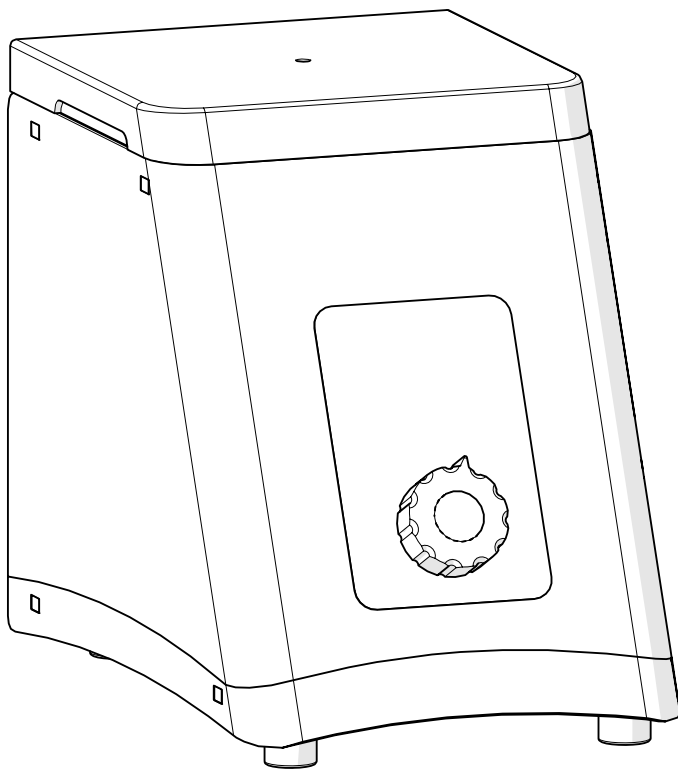

Data herein has been verified and validated. It is believed adequate for the intended use of the instrument. If the instrument or procedures are used for purposes over and above the capabilities specified herein, confirmation of the validity and suitability should be obtained; otherwise OMNI International does not guarantee results and assumes no obligation or liability. This publication is not a license to operate under, or a recommendation to infringe upon, any process patents.

This product is warranted to be free from defects in material and workmanship for a period of ONE YEAR from the date of delivery. OMNI International will repair or replace and return free of charge any part which is returned to its factory within said period, transportation prepaid by user, and which is found upon inspection to have been defective in materials or workmanship. This warranty does not include normal wear from use; it does not apply to any instrument or parts which have been altered by anyone other than an employee of OMNI International nor to any instrument which has been damaged through accident, negligence, failure to follow operating instructions, the use of electric currents or circuits other than those specified on the plate affixed to the instrument, misuse, or abuse. OMNI International reserves the right to change, alter, modify, or improve any of its instruments without any obligation whatever to make corresponding changes to any instrument previously sold or shipped.

THE FORGOING OBLIGATION IS IN LIEU OF ALL OBLIGATIONS AND LIABILITIES INCLUDING NEGLIGENCE AND ALL WARRANTIES OF MERCHANTABILITY OR OTHERWISE, EXPRESSED OR IMPLIED IN FACT OR BY LAW, AND STATE OUR ENTIRE AND EXCLUSIVE LIABILITY AND BUYERS EXCLUSIVE REMEDY FOR ANY CLAIM OF DAMAGES IN CONNECTION WITH THE SALE OR FURNISHING OF GOODS OR PARTS, THEIR DESIGN, SUITABILITY FOR USE, INSTALLATION, OR OPERATION. OMNI INTERNATIONAL WILL IN NO EVENT BE LIABLE FOR ANY SPECIAL OR CONSEQUENTIAL DAMAGES WHATSOEVER, AND THEIR LIABILITY UNDER NO CIRCUMSTANCES WILL EXCEED THE CONTRACT PRICE FOR THE GOODS FOR WHICH LIABILITY IS CLAIMED.

This product has been engineered for safety; however, basic safety precautions and common sense must always be demonstrated when using any electrical product.

- DO NOT attempt to modify any part of this product.
- DO NOT allow the machine to be submerged in any liquid.
- DO NOT use in any setting other than an indoor laboratory.
- Use this product only for its intended purpose.
- DO NOT use attachments not recommended by the manufacturer.
- DO NOT operate the product if it is damaged in any way.
- Keep this product away from heated surfaces.

Overview

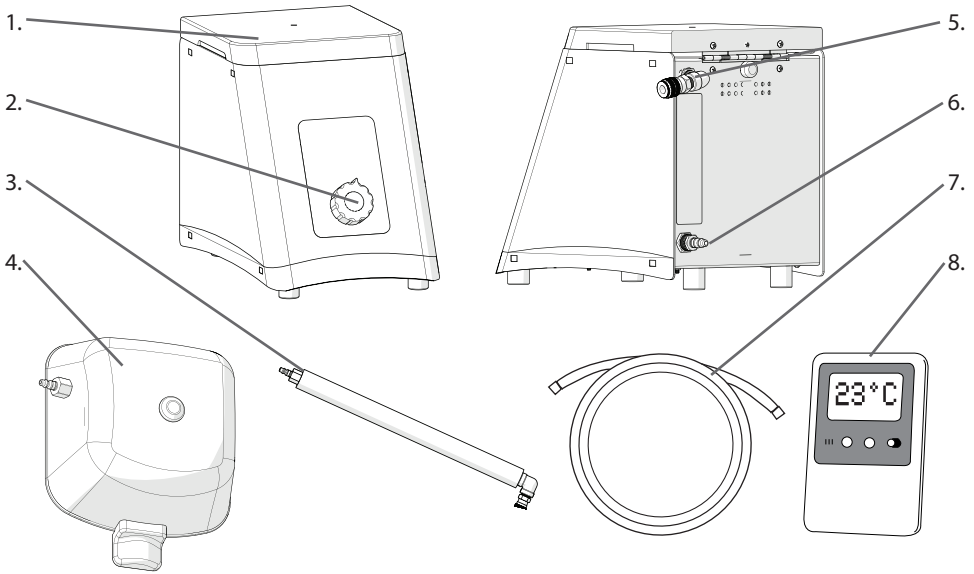

- | | |
|--------------------------|-------------------------|
| 1. Lid | 5. Cold Air Outflow |
| 2. Airflow Control Knob | 6. Compressed Air Input |
| 3. Insulated Cryo Hose | 7. Compressed Air Hose |
| 4. Bead Ruptor™ Cryo Lid | 8. External Thermometer |

The Bead Ruptor Cryo Cooling Unit consists of the following:

Description	Quantity
Bead Ruptor™ Cryo Cooling Unit	1
Insulated Cryo Hose	1
Bead Ruptor™ Cryo Lid	1
External Thermometer	1
Compressed Air Hose	1
Tool Kit	1
User Manual	1
Not Included	
Hose Barb - 3/8" or equivalent	1

Installation

Removing the Bead Ruptor™ Bead Mill Homogenizer Lid

1.

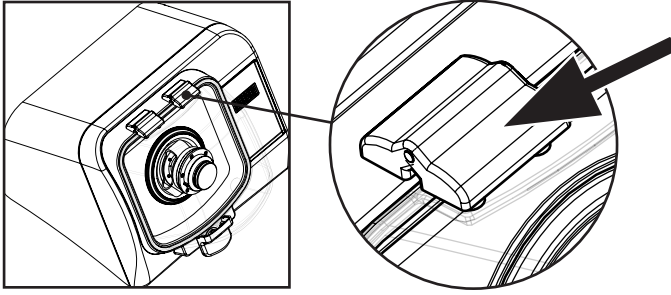

Locate Lid Hinges.

2.

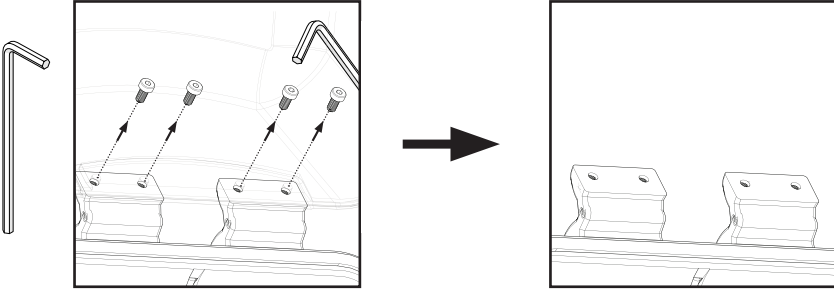

Lift Lid and remove 4 screws using the provided Allen Key. Remove Lid

Replace with Bead Ruptor™ Cryo Lid (Black)

3.

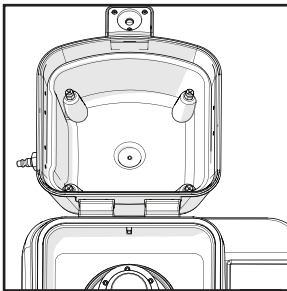

Align black Cryo lid onto the Bead Ruptor™.

4.

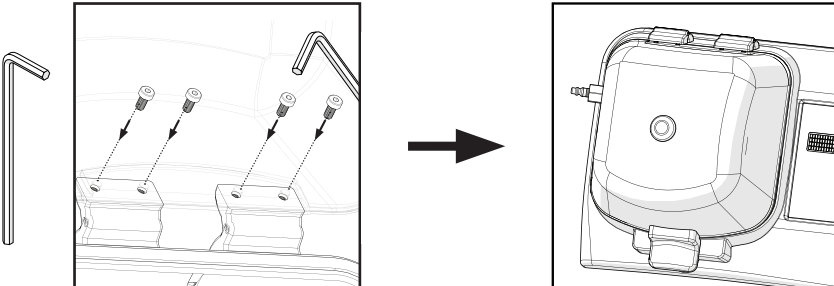

Replace the four screws and tighten using the provided Allen Key.

Installation

Install the External Thermometer

1.

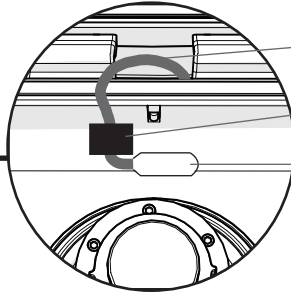
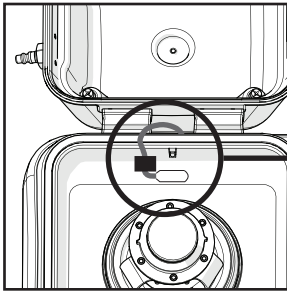

Thermometer probe wire

Couple clip

Thermometer probe

Position the Thermometer Probe under the Bead Ruptor lid as shown, using the Couple Clip to secure the thermometer probe wire under the Bead Ruptor lid.

2.

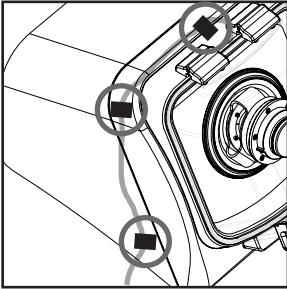

Place remaining Couple Clips as shown. Guide the thermometer probe wire through the clips.

3.

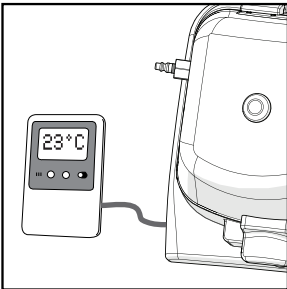

Plug the thermometer probe wire into the External Thermometer.

NOTE: The Digital Thermometer has been preset to Celsius with alarms to be triggered if temperatures reach below -10°C or over 70°C .

Installation

Install Intake and Output Hoses

NOTE: Compressed ISO8573 Class 2 or better air is required to use the Bead Ruptor™ Cryo unit: Total oil < 0.1 mg/m³, vapor pressure dew point < -50°C. The compressed air hose can be fitted to a standard medical air regulator using a 3/8" hose clamp.

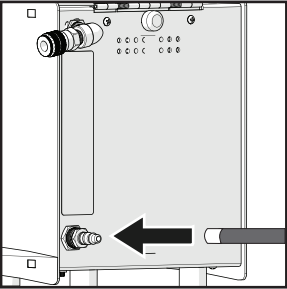
1.  Connect the hose from air supply to the rear of the Bead Ruptor™ Cryo unit.

Note: An optional hose with a “quick connect” coupling has been included with the Bead Ruptor™ Cryo.

An additional fitting is required to connect the hose to the air supply.

Hose Barb - 3/8" or equivalent.

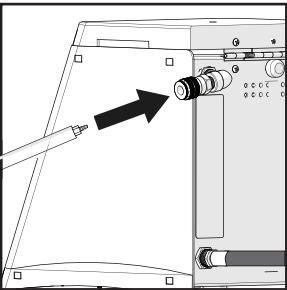
2.  Connect the straight end of the Insulated Cryo Hose to the Bead Ruptor™ Cryo Unit.

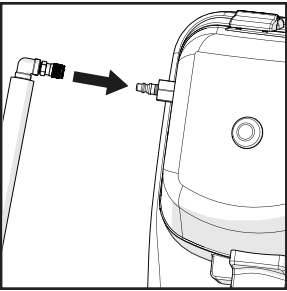
3.  Connect the 90° elbow end of the Insulated Cryo Hose to the Bead Ruptor™ Homogenizer Lid.

Recommended Dry Air Guidelines

- Obtain a high-pressure cylinder of Medical Air. Medical Air is a blend of nitrogen and oxygen that contains virtually no traces of oil or water vapor.

OR

- Between an air compressor and the Bead Ruptor™ Cryo Unit inlet, use a refrigerated air dryer or desiccant dryer. These systems are specified in the lowest dew point that can be reached.

- **DO NOT** use inlet pressure below 55 PSI or above 120 PSI.

Operation

Liquid Nitrogen

Pre - Cooling

WARNING: Wear eye, face, hand and skin protection when working with liquid nitrogen. Operate in a well ventilated area.

PRE-COOLING - follow pre-cooling procedure before homogenizing samples.

NOTE: Do not load samples into the Bead Ruptor processing chamber prior to pre-cooling.

1.



- Purge air lines by running dry air for 30 seconds at the MAX setting.

- Turn knob to the Off position.

2.

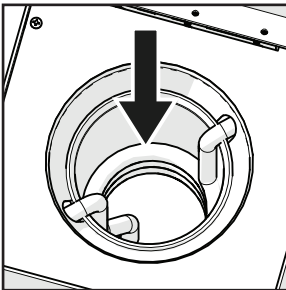

Add 0.5 L or 16 oz. of liquid nitrogen to the chamber, fill to 3 inches (7.6 cm) below the top of the chamber.

NOTE: The copper coils in the chamber must be completely covered by liquid nitrogen.

3.

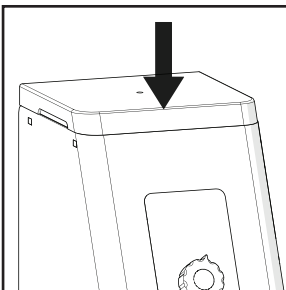

Close the lid of the Bead Ruptor™ Cryo unit and turn the air flow control knob counterclockwise to begin the flow of air into the processing chamber. Pre-cool the Bead Ruptor™ Homogenizer processing chamber to 0°C.

WARNING: DO NOT pre-cool the processing chamber below 0°C.

Operation

Liquid Nitrogen Homogenizing Samples

1.



Ensure that the knob of the Bead Ruptor™ Cryo is in the off position and all hoses are connected correctly.

2.

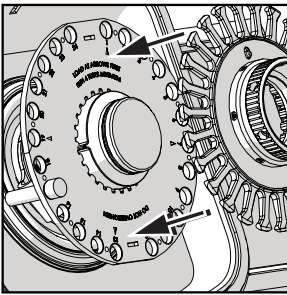

- Load samples into the Bead Ruptor™ Homogenizer.
- Install Finger Plate
- Set the desired time, speed dwell and number of cycles on the Bead Ruptor™ Homogenizer.

WARNING: The BR Cryo is not compatible with Tube Carriages > 7 mL or the 48 Position 2 mL Carriage.

3.

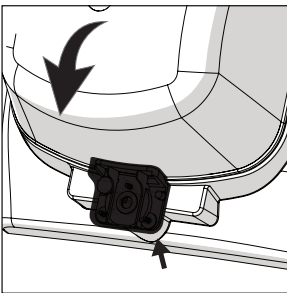

Close the Bead Ruptor™ Homogenizer lid.

4.

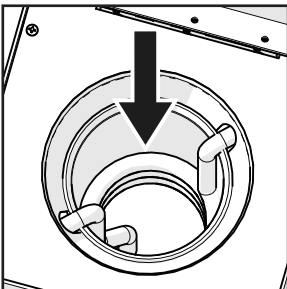



Add 0.5 L or 16 oz. of liquid nitrogen to the chamber of the Bead Ruptor™ Cryo unit, fill to 3 inches (7.6 cm) below the top of the chamber.

NOTE: The copper coils in the chamber must be completely covered by liquid nitrogen.

CAUTION: 55-120 PSI is the recommended air pressure for use with the Bead Ruptor™ Cryo. Pressure above 120 PSI could damage internal components.

Operation

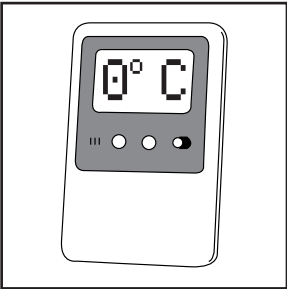
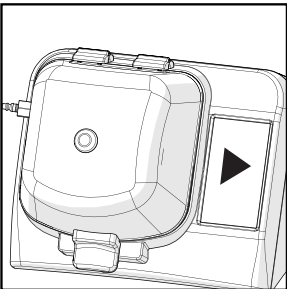
Liquid Nitrogen Homogenizing Samples

5.  Turn Airflow control knob counter clockwise to begin cooling.
6.  Allow air to flow until the External Thermometer reads 0°C.
7.  Once the temperature has reached 0°C, press RUN on the Bead Ruptor to begin homogenization.
8.  When the cycle has ended:
 - Turn off compressed air supply
 - Turn off Bead Ruptor™ Cryo
 - Open the lid of the Bead Ruptor™ Homogenizer and remove samples.**CAUTION:** Allow liquid nitrogen to evaporate before attempting to move the Bead Ruptor™ unit.

WARNING: Avoid direct skin contact with Bead Ruptor™ Cryo and Bead Ruptor™ Homogenizer components after exposure to liquid nitrogen. Always use protective gloves.

Operation

Dry Ice Pre-Cooling

**Liquid nitrogen will provide the best results.
However, dry ice and ethanol may be used.**

WARNING: Wear eye, face, hand and skin protection when working with Dry Ice. Operate in a well ventilated area.

PRE-COOLING - follow pre-cooling procedure before homogenizing samples.

NOTE: Do not load samples into the Bead Ruptor processing chamber prior to pre-cooling.

1.



- Purge air lines by running dry air for 30 seconds at the MAX setting.

- Turn knob to the **Off** position.

2.

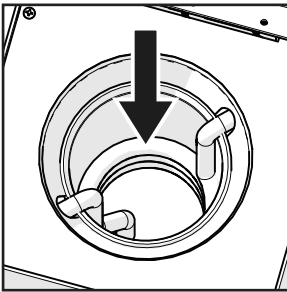

- Add 0.5 L (16 Oz.) of dry ice to the Bead Ruptor™ Cryo chamber.

- Add 0.5 L (16 oz.) of ethanol to the Bead Ruptor™ Cryo chamber and let the mixture sit for five minutes to allow the coil to cool.

NOTE: The copper coils in the chamber must be completely covered by the ethanol and dry ice.

WARNING: Do not fill more than 3/4 of the chamber volume as leaking may occur.

3.

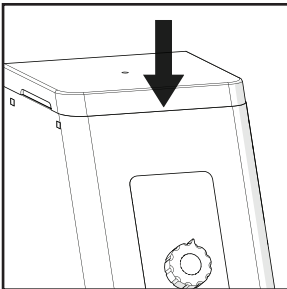

Close the lid of the Bead Ruptor™ Cryo unit and turn the air flow control knob counterclockwise to begin the flow of air into the processing chamber. Pre-cool the Bead Ruptor™ Homogenizer processing chamber to -5°C.

WARNING: DO NOT pre-cool the processing chamber below -5°C.

Operation

Dry Ice

Homogenizing Samples

1.



Ensure that the knob of the Bead Ruptor™ Cryo is in the off position and all hoses are connected correctly.

2.

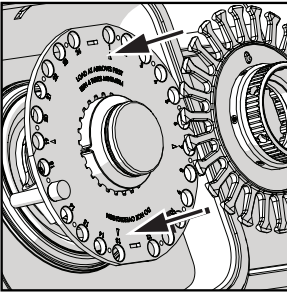

- Load samples into the Bead Ruptor™ Homogenizer.
- Install Finger Plate
- Set the desired time, speed dwell and number of cycles on the Bead Ruptor™ Homogenizer.

WARNING: BR Cryo is compatible with 1.5 mL, 2 mL and 7 mL tubes only.

3.

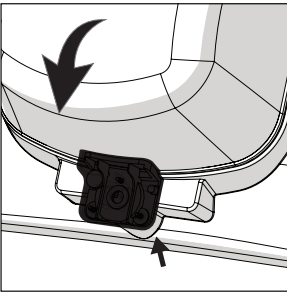

Close the Bead Ruptor™ Homogenizer lid.

4.

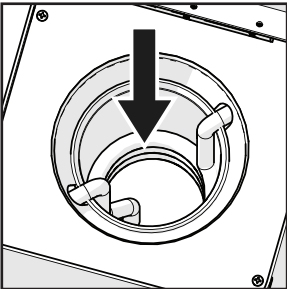

- Add 0.5 L (16 Oz.) of dry ice to the Bead Ruptor™ Cryo chamber.

- Add 0.5 L (16 oz.) of ethanol to the Bead Ruptor™ Cryo chamber and let the mixture sit for five minutes to allow the coil to cool.



NOTE: The copper coils in the chamber must be completely covered by the ethanol and dry ice.

WARNING: Do not fill more than 3/4 of the chamber volume as leaking may occur.

CAUTION: 55-120 PSI is the recommended air pressure for use with the Bead Ruptor™ Cryo. Pressure above 120 PSI could damage internal components.

Operation

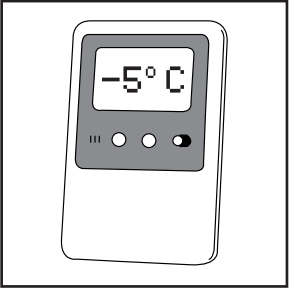
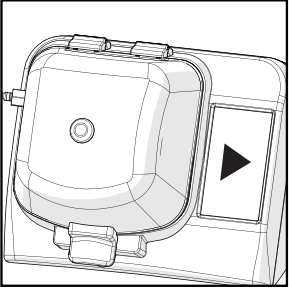
Dry Ice Homogenizing Samples

5.  Turn Airflow control knob counter clockwise to begin cooling.
6.  Allow air to flow until the External Thermometer reads -5°C (23°F)
7.  Once the temperature has reached -5°C , press RUN on the Bead Ruptor™ Homogenizer to begin homogenization.
8.  When the cycle has ended:
 - Turn off compressed air supply
 - Turn off Bead Ruptor™ Cryo
 - Open the lid of the Bead Ruptor™ Homogenizer and remove samples.

CAUTION: Allow the dry ice to evaporate and dispose of remaining alcohol before attempting to move the Bead Ruptor™ Homogenizer unit.

WARNING: Avoid direct skin contact with Bead Ruptor™ Homogenizer and Bead Ruptor™ Cryo components after exposure to dry ice. Always use protective gloves.

Trouble Shooting

Problem	Possible Cause	Action
Cold air is not flowing into the Bead Ruptor™ Homogenizer.	The cooling system is not supplied with compressed air.	<ol style="list-style-type: none"> 1. Check that the air source is open. 2. Check that there are no leaks in the hoses.
	<ul style="list-style-type: none"> - The airflow nozzles are obstructed. - The air purity is lower than recommended. 	<ol style="list-style-type: none"> 1. Wait for the units to completely de-frost. 2. Ensure the air purity is 99% and the water content <5ppm.
One or several outflows do not work.	One or more nozzles are defective.	Contact Technical Support
System is not performing optimally	The airflow holes are obstructed.	<ol style="list-style-type: none"> 1. Wait for the units to completely de-frost. 2. If problem persists, contact technical support.
	The outflow control valves or regulator are defective.	Contact technical support.

RISKS ASSOCIATED WITH LIQUID NITROGEN: It is recommended that the Bead Ruptor™ Cryo be operated with liquid nitrogen. Liquid nitrogen is a colorless, odorless, highly refrigerated gas (around -196°C). The main risks associated with the handling of this product are asphyxiation and burns. To protect against burns, the operator must wear equipment that protect the eyes, face and skin. Use liquid nitrogen in a well ventilated area. It is advised to have the safety instructions about the risks and precautions associated with the utilization of liquid nitrogen on hand.

DO NOT: transport the unit before emptying the nitrogen tank completely.

DO NOT: overfill the tank with liquid nitrogen.

DO NOT: use compressed gases which are not specified.

DO NOT: operate the Bead Ruptor™ Cryo cooling unit with the Bead Ruptor™ Homogenizer 15 mL, 30 mL, or 50 mL tube carriages. Damage to the Bead Ruptor™ Cryo lid will result.

DO NOT: disconnect the in and out airflow hoses when they are under pressure.

DO NOT: apply air pressure of more than 120 PSI as this may damage the internal components or cause liquid nitrogen to be spilled.

DO NOT: install unauthorized components or accessories as this will void the warranty.

DO NOT: transport the unit packaging other than the original.

DO NOT: attempt to service the Bead Ruptor™ Cryo Cooling Unit in a manner other than those discussed in this manual. For any issue that is unsuccessfully corrected using this guide, please contact your authorized dealer or call OMNI International, a PerkinElmer company at 1-800-776-4431.



OMNI
International

935 Cobb Place Blvd. NW
Kennesaw, GA 30144
800.776.4431 • 770.421.0058
www.omni-inc.com